

## wedi Sanoasa *Bellina* | bench/carrier element, slope to front

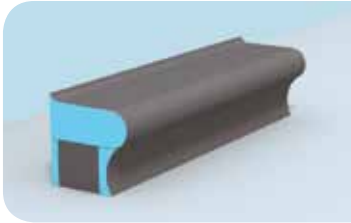

### Description

wedi Sanoasa Bellina, bench element, slope to front

Length

Order no.

wedi Sanoasa Bellina, bench element, slope to front

1000 mm

07-64-48/015

wedi Sanoasa Bellina, carrier element, round finish length

2000 mm

07-64-41/000

1000 mm

07-64-41/600

### Options

Bench element with integrated electrical heating set

2000 mm

–

Bench element with integrated hot water heating set

2000 mm

–

- !** • Each bench element (2000 mm) requires two carrier elements.
- The bench element shall be glued to the carrier element using wedi 610 adhesive sealant.
- The article is immediately available.
- For hot water or electrical heating sets which are to be installed on site, the delivery time is approx. 4–5 weeks.

### m<sup>2</sup> Bench element (for 2000 mm length):

- Front: approx. 1.45 m<sup>2</sup>
- Rear panel: approx. 0.50 m<sup>2</sup>
- Sides: approx. 0.19 m<sup>2</sup>

### Carrier elements Bellina (for 2000 mm length):

- Front: approx. 0.60 m<sup>2</sup>
- Rear panel: approx. 0.50 m<sup>2</sup>
- Sides: approx. 0.19 m<sup>2</sup>

### Technical drawings

Sanoasa Bellina, round finish length

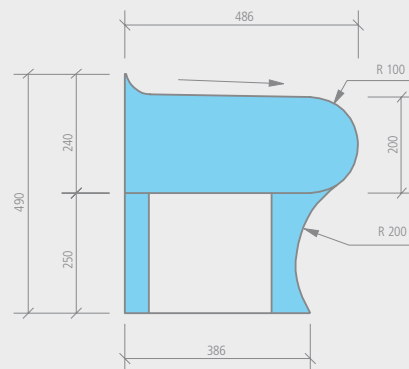

## Sanoasa Bellina benches

### wedi Sanoasa *Bellina linea* | bench/carrier element, slope to front

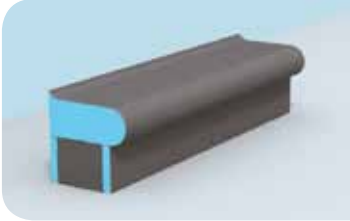

#### Description

wedi Sanoasa Bellina, bench element, slope to front

Length

Order no.

1000 mm

07-64-48/015

wedi Sanoasa Bellina, bench element, slope to front

2000 mm

07-64-41/000

wedi Sanoasa Bellina *linea*, carrier element, straight finish length

1000 mm

07-64-41/500

#### Options

Bench element with integrated electrical heating set

2000 mm

–

Bench element with integrated hot water heating set

2000 mm

–

- !** Each bench element (2000 mm) requires two carrier elements.
- The bench element shall be glued to the carrier element using wedi 610 adhesive sealant.
- The article is immediately available.
- For hot water or electrical heating sets which are to be installed on site, the delivery time is approx. 4–5 weeks.

#### m<sup>2</sup> Bench element (for 2000 mm length):

- Front: approx. 1.45 m<sup>2</sup>
- Rear panel: approx. 0.50 m<sup>2</sup>
- Sides: approx. 0.19 m<sup>2</sup>

#### Carrier elements *Bellina linea*

(for 2000 mm length):

- Front: approx. 0.50 m<sup>2</sup>
- Rear panel: approx. 0.50 m<sup>2</sup>
- Sides: approx. 0.20 m<sup>2</sup>

#### Technical drawings

Sanoasa Bellina *linea*, straight finish length

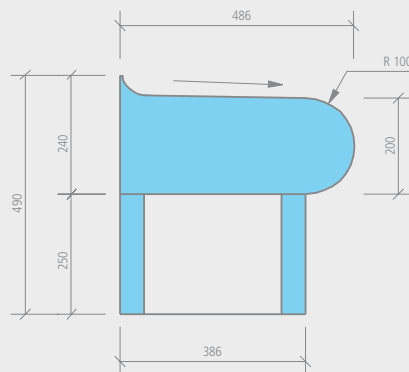

## wedi Sanoasa *Bellina linea* | corner element 90°, straight, slope to front

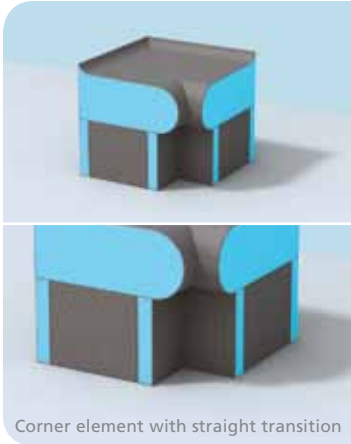

Corner element with straight transition

### Description

wedi Sanoasa Bellina, bench corner element 90°, straight, slope to front

wedi Sanoasa Bellina *linea*, carrier corner element 90°

Length x width x height

Order no.

550 x 550 x 240 mm

07-64-48/004

550 x 550 x 250 mm

07-64-48/005



- The bench element shall be glued to the carrier element using wedi 610 adhesive sealant.
- Delivery time is approx. 2 – 3 weeks.



Bench corner element:

- Front: approx. 0.35 m<sup>2</sup>
- Rear panel: approx. 0.30 m<sup>2</sup>
- Sides: approx. 0.19 m<sup>2</sup>

Carrier corner element:

- Front: approx. 0.10 m<sup>2</sup>
- Rear panel: approx. 0.30 m<sup>2</sup>
- Sides: approx. 0.20 m<sup>2</sup>

### Technical drawings

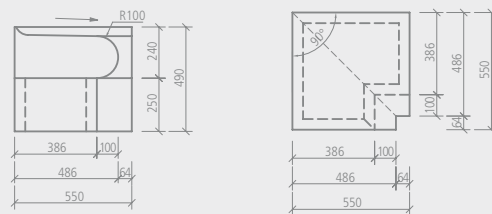

## wedi Sanoasa *Bellina linea* | corner element 90°, round, slope to front



Corner element with round transition

### Description

wedi Sanoasa Bellina, bench corner element 90°, round, slope to front

wedi Sanoasa Bellina *linea*, carrier corner element 90°

Length x width x height

Order no.

736 x 736 x 240 mm

07-64-48/000

736 x 736 x 250 mm

07-64-48/001



- The bench element shall be glued to the carrier element using wedi 610 adhesive sealant.
- Delivery time is approx. 2 – 3 weeks.



Bench corner element:

- Front: approx. 0.45 m<sup>2</sup>
- Rear panel: approx. 0.30 m<sup>2</sup>
- Sides: approx. 0.19 m<sup>2</sup>

Carrier corner element:

- Front: approx. 0.15 m<sup>2</sup>
- Rear panel: approx. 0.30 m<sup>2</sup>
- Sides: approx. 0.20 m<sup>2</sup>

### Technical drawings

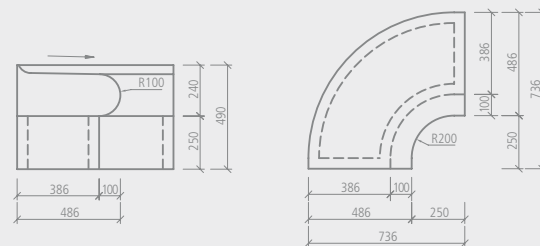

## Sanoasa Bellina benches

### wedi Sanoasa *Bellina* *linea* | corner element 135°, straight, slope to front

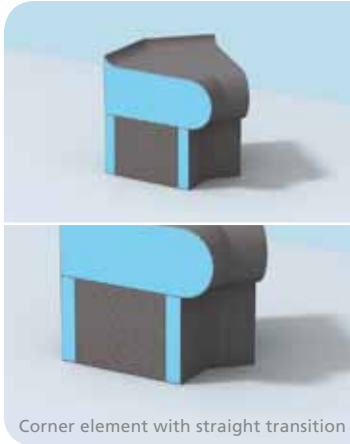

Corner element with straight transition

#### Description

wedi Sanoasa Bellina, bench corner element 135°, straight, slope to front  
wedi Sanoasa Bellina *linea*, carrier corner element 135°

Length x width x height

Order no.

486 x 486 x 240 mm

07-64-48/006

512 x 485 x 250 mm

07-64-48/007

- !** The bench element shall be glued to the carrier element using wedi 610 adhesive sealant.
- Delivery time is approx. 2 – 3 weeks.

#### m<sup>2</sup> Bench corner element:

- Front: approx. 0.25 m<sup>2</sup>
- Rear panel: approx. 0.15 m<sup>2</sup>
- Sides: approx. 0.19 m<sup>2</sup>

#### Carrier corner element:

- Front: approx. 0.10 m<sup>2</sup>
- Rear panel: approx. 0.15 m<sup>2</sup>
- Sides: approx. 0.20 m<sup>2</sup>

#### Technical drawings

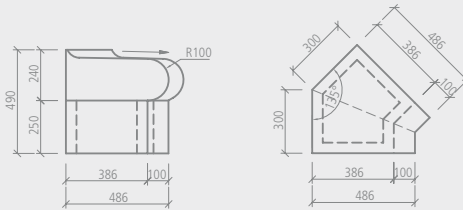

### wedi Sanoasa *Bellina* *linea* | corner element 135°, round, slope to front

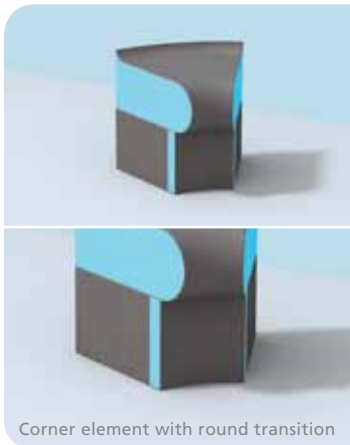

Corner element with round transition

#### Description

wedi Sanoasa Bellina, bench corner element 135°, round, slope to front  
wedi Sanoasa Bellina *linea*, carrier corner element 135°

Length x width x height

Order no.

638 x 608 x 240 mm

07-64-48/002

638 x 486 x 250 mm

07-64-48/003

- !** The bench element shall be glued to the carrier element using wedi 610 adhesive sealant.
- Delivery time is approx. 2 – 3 weeks.

#### m<sup>2</sup> Bench corner element:

- Front: approx. 0.35 m<sup>2</sup>
- Rear panel: approx. 0.20 m<sup>2</sup>
- Sides: approx. 0.19 m<sup>2</sup>

#### Carrier corner element:

- Front: approx. 0.15 m<sup>2</sup>
- Rear panel: approx. 0.20 m<sup>2</sup>
- Sides: approx. 0.20 m<sup>2</sup>

#### Technical drawings

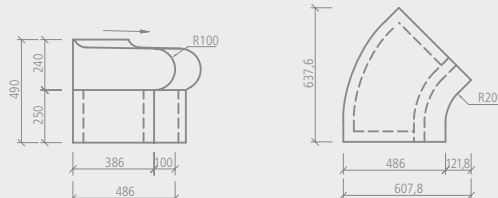

## wedi Sanoasa *Bellina linea* | end element, left, R=200, slope to front



### Description

wedi Sanoasa Bellina, bench end element left, R=200,  
slope to front

wedi Sanoasa Bellina *linea*, carrier end element, R=200

Length x width x height

Order no.

486 x 300 x 240 mm

07-64-48/011

386 x 200 x 250 mm

07-64-48/013



- The bench element shall be glued to the carrier element using wedi 610 adhesive sealant.
- Delivery time is approx. 2 – 3 weeks.



### Bench end element:

- Front: approx. 0.30 m<sup>2</sup>
- Rear panel: approx. 0.20 m<sup>2</sup>
- Sides: approx. 0.19 m<sup>2</sup>

### Carrier end element:

- Front: approx. 0.15 m<sup>2</sup>
- Rear panel: approx. 0.15 m<sup>2</sup>
- Sides: approx. 0.20 m<sup>2</sup>

### Technical drawings

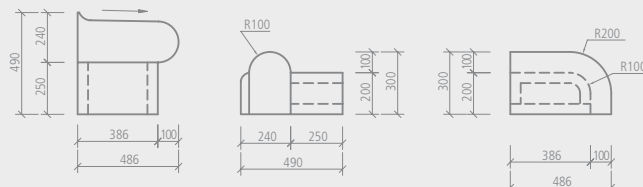

## wedi Sanoasa *Bellina linea* | end element, left, R=486, slope to front



### Description

wedi Sanoasa Bellina, bench end element left, R=486,  
slope to front

wedi Sanoasa Bellina *linea*, carrier end element, R=486

Length x width x height

Order no.

600 x 486 x 240 mm

07-64-48/008

500 x 386 x 250 mm

07-64-48/010



- The bench element shall be glued to the carrier element using wedi 610 adhesive sealant.
- Delivery time is approx. 2 – 3 weeks.



### Bench end element:

- Front: approx. 0.40 m<sup>2</sup>
- Rear panel: approx. 0.20 m<sup>2</sup>
- Sides: approx. 0.19 m<sup>2</sup>

### Carrier end element:

- Front: approx. 0.20 m<sup>2</sup>
- Rear panel: approx. 0.25 m<sup>2</sup>
- Sides: approx. 0.20 m<sup>2</sup>

### Technical drawings

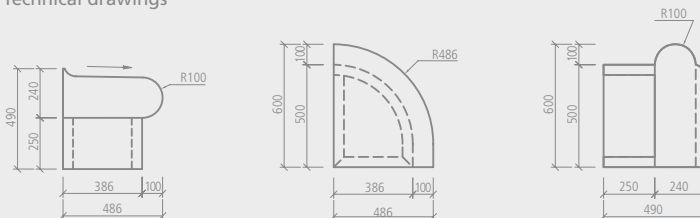

## Sanoasa Bellina benches

### wedi Sanoasa *Bellino linea* | end element, right, R=200, slope to front



Description	Length x width x height	Order no.
wedi Sanoasa Bellina, bench end element right, R=200, slope to front	486 x 300 x 240 mm	07-64-48/012
wedi Sanoasa Bellina <i>linea</i> , carrier end element, R=200	386 x 200 x 250 mm	07-64-48/013

- !** • The bench element shall be glued to the carrier element using wedi 610 adhesive sealant.
  - Delivery time is approx. 2 – 3 weeks.
- |   |   |
|---|---|
| <b>m<sup>2</sup></b> Bench end element:   | Carrier end element:                      |
| • Front: approx. 0.30 m <sup>2</sup>      | • Front: approx. 0.15 m <sup>2</sup>      |
| • Rear panel: approx. 0.20 m <sup>2</sup> | • Rear panel: approx. 0.15 m <sup>2</sup> |
| • Sides: approx. 0.19 m <sup>2</sup>      | • Sides: approx. 0.20 m <sup>2</sup>      |

#### Technical drawings

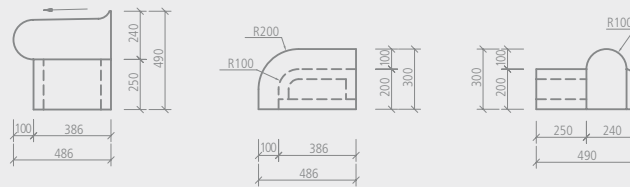

### wedi Sanoasa *Bellino linea* | end element, right, R=486, slope to front



Description	Length x width x height	Order no.
wedi Sanoasa Bellina, bench end element right, R=486, slope to front	600 x 486 x 240 mm	07-64-48/009
wedi Sanoasa Bellina <i>linea</i> , carrier end element, R=486	500 x 386 x 250 mm	07-64-48/010

- !** • The bench element shall be glued to the carrier element using wedi 610 adhesive sealant.
  - Delivery time is approx. 2 – 3 weeks.
- |   |   |
|---|---|
| <b>m<sup>2</sup></b> Bench end element:   | Carrier end element:                      |
| • Front: approx. 0.40 m <sup>2</sup>      | • Front: approx. 0.20 m <sup>2</sup>      |
| • Rear panel: approx. 0.20 m <sup>2</sup> | • Rear panel: approx. 0.25 m <sup>2</sup> |
| • Sides: approx. 0.19 m <sup>2</sup>      | • Sides: approx. 0.20 m <sup>2</sup>      |

#### Technical drawings

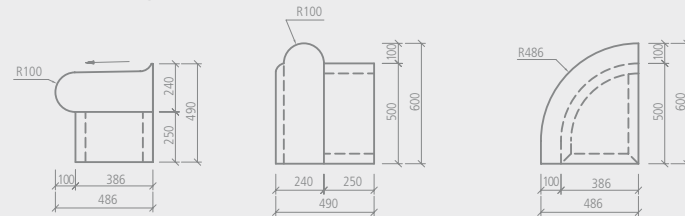

## wedi Sanoasa *Bellina* & *Bellina linea* | armrest

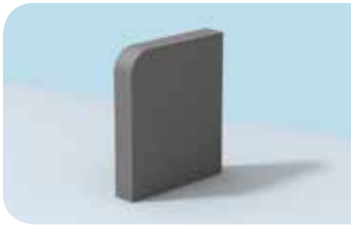

### Description

wedi Sanoasa Bellina & Bellina *linea*, armrest

Length x width x height

550 x 105 x 650 mm

Order no.

07-64-48/014

- ! • The Sanoasa Bellina & Bellina *linea* armrest can be installed equally on the right or the left.
- The armrest must be glued to the bench element and carrier element using wedi 610 adhesive sealant.
- Delivery time is approx. 2 – 3 weeks.

### m<sup>2</sup> Armrest:

- Front: approx. 0.65 m<sup>2</sup>
- Rear panel: approx. 0.10 m<sup>2</sup>
- Sides: approx. 0.72 m<sup>2</sup>

### Technical drawings

